

Article number: 208050091

Description: E+G Sphericalwasher male DIN 6319-10,5-C-NI
Stainless Steel 1.4305

Measures

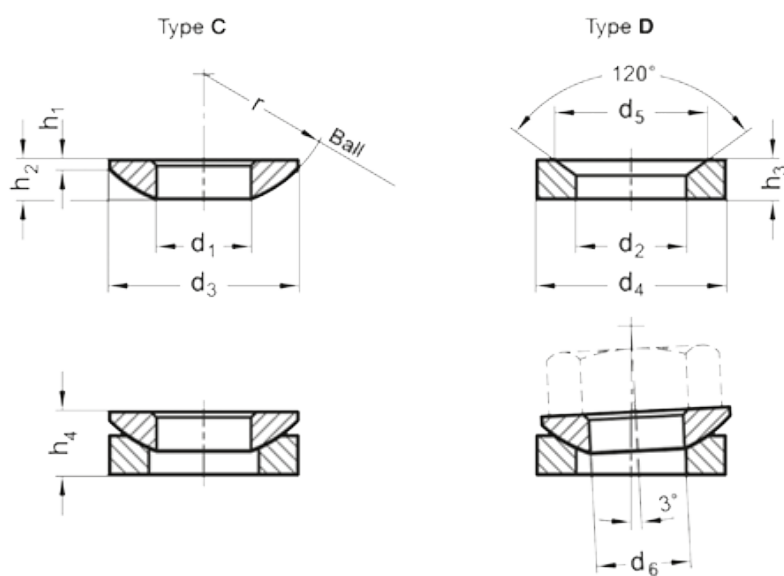

$d_1 = 10.5$

$d_3 = 21$

$d_6 = M10$

$H_1 = 0.8$

$H_2 = 4.0$

$H_4 = 6.5$

$r = 15$